

XCT50_Y 汽车起重机 / Truck Crane

技术规格书

Technical Specifications

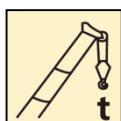

50 t

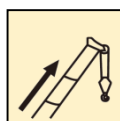

43.5 m

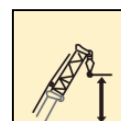

59.5 m



目录

Contents

目录

Contents

尺寸参数 Dimensions	3-4
技术规格 Technical specifications	5-10
重量/作业速度 Weight / Working speeds	11
臂架组合方案 Boom / Jib combinations	12
主臂 Boom	13-15
副臂 Jib	16-17
注意事项 Notes	18
符号标识 Description of symbols	19
主要技术参数表 Table of main technical parameters	20-21

尺寸参数 (右驾 Right-hand drive)

Dimensions

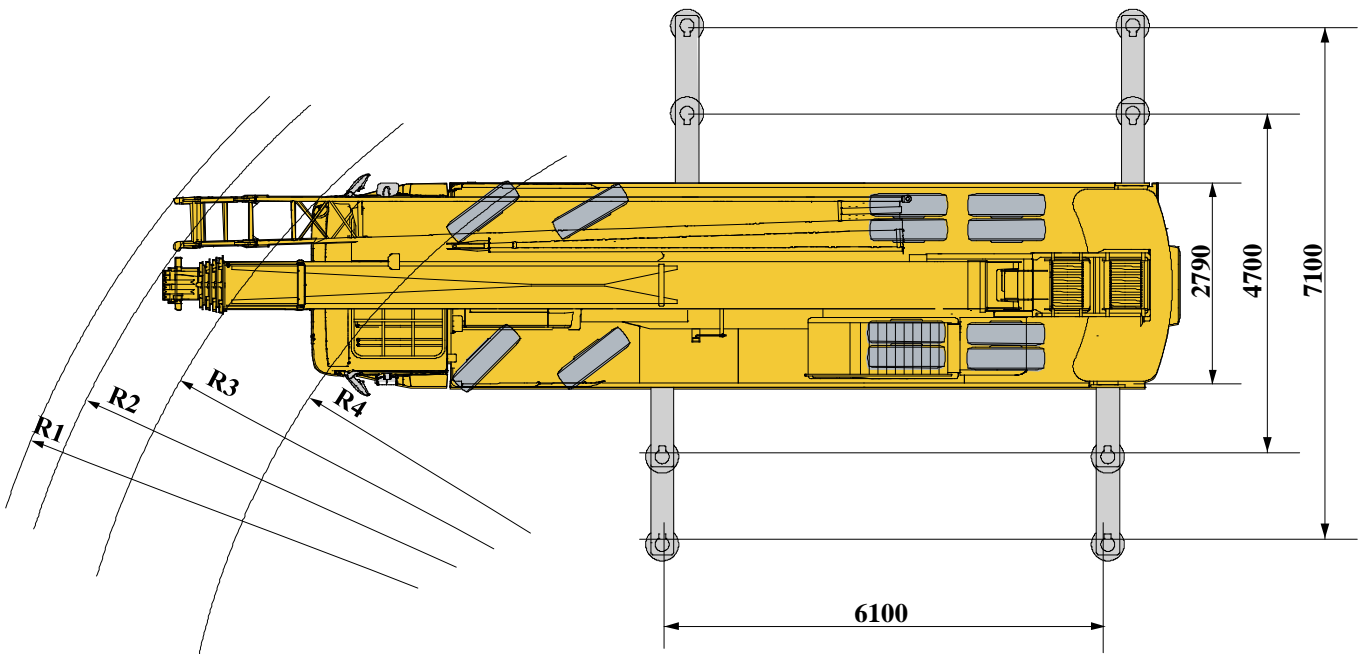
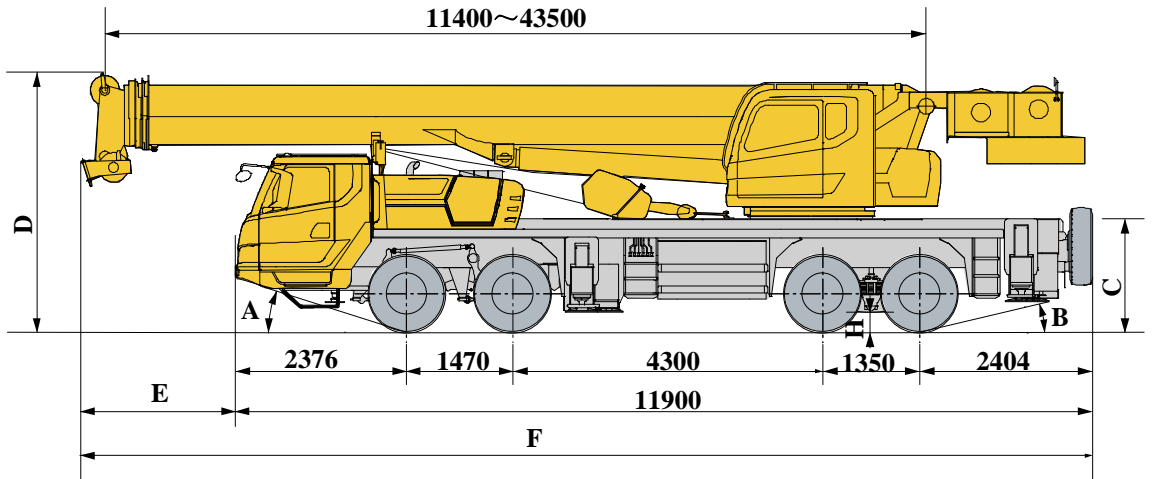

副臂型式 Jib		A	B	C	D	E	F	R1	R2	R3	R4	H
侧置副臂 Swing-away jib	315/80R22.5	19°	13°	1559	3615	2145	14045	15100	14630	13600	12000	260
腹置副臂 Under slung jib	315/80R22.5	19°	13°	1559	4050	2700	14600	—	15120	13600	12000	260

尺寸参数 (左驾 Left-hand drive)

Dimensions

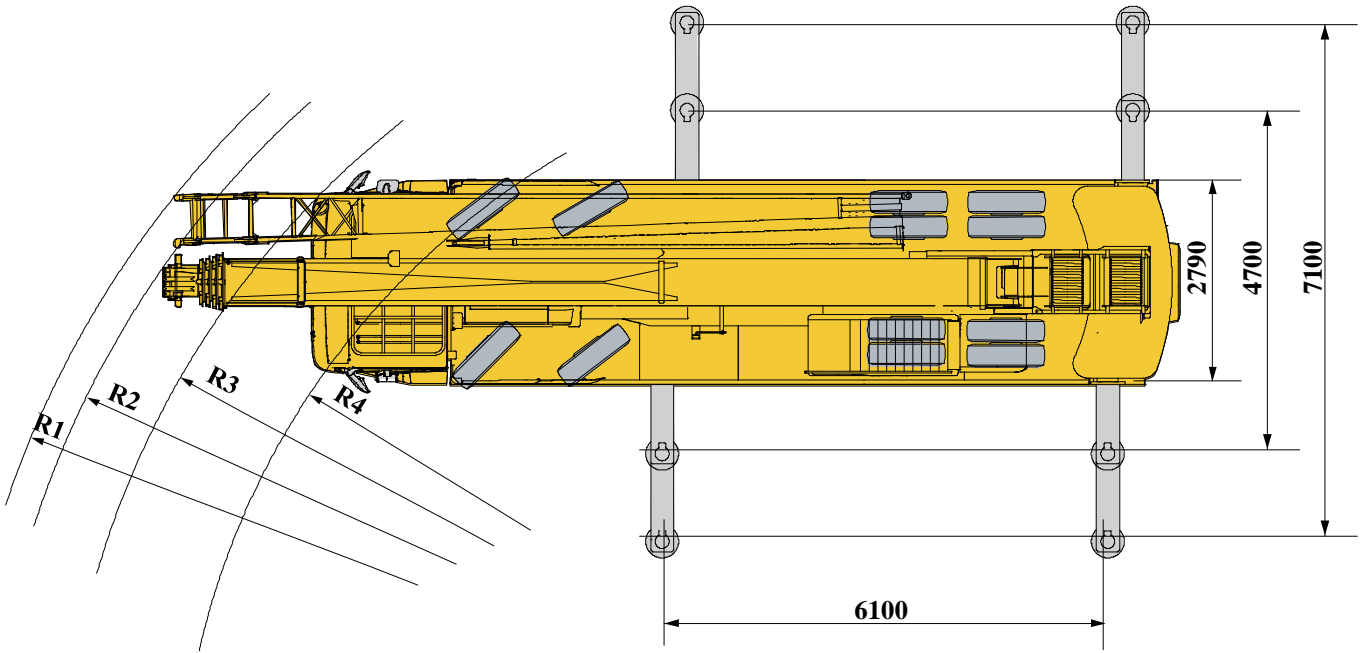
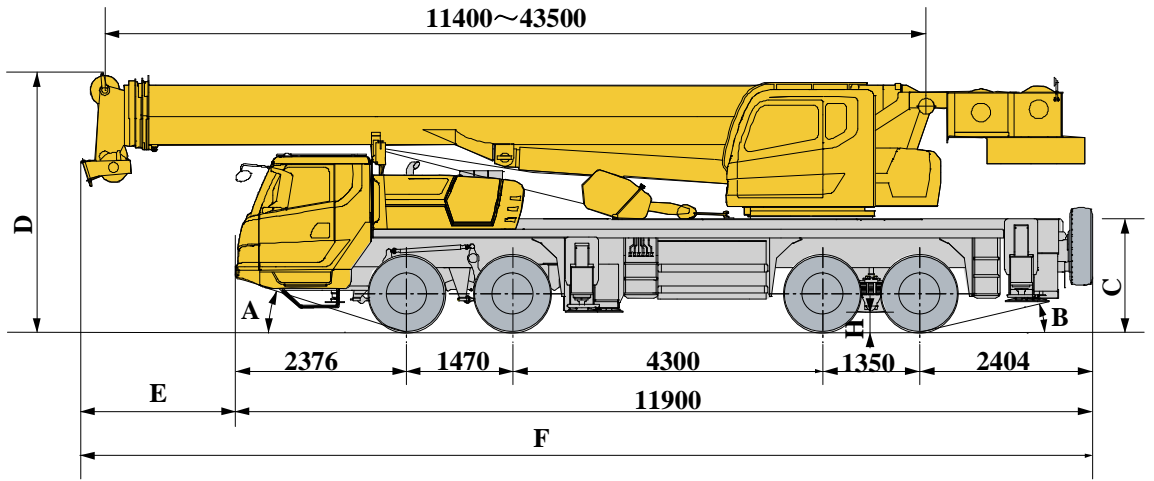

	A	B	C	D	E	F	R1	R2	R3	R4	H
315/80R22.5	19°	13°	1559	3615	2145	14045	15100	14630	13600	12000	260

技术规格

Technical specifications

	底盘	配置	变速箱	
车架	徐工设计、制造，全覆盖式走台板，防扭转箱型结构，高强度钢材制造。	●	采用陕齿机械式变速箱，手动远距离软轴操纵，全同步器；9个前进档，1个倒档，工作稳定、可靠。	●
支腿	4支腿，带第五支腿。纵向H形布置，操作杆控制液压动作。可由底盘任意一侧同时或单独控制各支腿的动作，设有水平仪。带第五支腿，支腿油缸均设有单向阀，且垂直支腿带有双向液压锁。 支脚盘尺寸：Φ450mm 最大起重量时支腿反力：410kN	●	车桥 高强度桥，引进国外厂家制造，性能可靠。先进技术，名牌厂家制造，性能可靠。	●
发动机	中国重型汽车集团，直列、水冷、四冲程、增压中冷、高压共轨； WD615.334，额定功率247kW/2200rpm，最大扭矩1350Nm/1100-1600rpm，国三排放标准； 燃油箱容积：300L。	● 右驾机型	悬挂 后悬挂系统，采用V型推力杆结构、橡胶悬架，增加底盘行驶稳定性，减少轮胎的磨损。	● 右驾机型
	东风康明斯，直列、水冷、四冲程、增压中冷、高压共轨； QSL8.9-C325-30，额定功率242kW/2100rpm，最大扭矩1385Nm/1500rpm，Stage III 排放标准。 燃油箱容积：300L。	○ 右驾机型	后悬挂系统，采用V型推力杆结构、钢板弹簧悬架，增加底盘行驶稳定性，减少轮胎的磨损。	● 左驾机型
	潍柴动力，直列、水冷、四冲程、增压中冷、高压共轨； WP9H336E62，额定功率247kW/1900rpm，最大扭矩1600Nm/(1000-1400)rpm，BS-IV排放标准。 燃油箱容积：320L。	○ 右驾机型	轮胎 315/80R22.5，无内胎轮胎，重量轻，散热好，行驶噪音低，承载力强，使用寿命长。	●
	中国重型汽车集团，直列、水冷、四冲程、增压中冷、高压共轨； D10.34-50，额定功率249kW/1900rpm，最大扭矩1490Nm/1200-1500rpm，国五排放标准。 燃油箱容积：300L。	● 左驾机型	制动 行车制动：脚踏板操纵的双回路气压制动。第一回路作用于一、二轴车轮上，第二回路作用于三、四轴车轮上。 驻车制动：弹簧储能制动，作用于二、三、四轴车轮上； 辅助制动：发动机缸内制动、排气制动，安全可靠，延长制动摩擦片使用寿命。	●
			转向 机械式转向机构，带有液压助力。	●
			驾驶室 豪华驾驶室。配备电动升降器的安全玻璃、可调式座椅、简易卧铺、电动调节后视镜、可调节高度及角度方向盘、液晶显示器和收放机等。标配冷暖空调。	●

技术规格

Technical specifications

电气系统	直流24伏特，串联 12 伏特的电池组 2 个。	●
	发电机：28±0.3 伏特，70 安培（或 80安培）。	●
安全装置	液压双向锁	●
	旋转报警灯	○
	倒车影像	○
	ABS	○
	黄色反光标识	○
	右驾机型	

	上车	配置
结构	徐工设计、制造，高强度钢材制造。	●
液压系统	专用节流装置匹配阀后补偿负载敏感设计，系统最低流量更稳定，系统刚度更合理，作业微动性、平顺性更突出；采用分合流技术，起升、变幅、伸缩双泵合流；风冷式液压油散热器； 液压油箱容积：600L	●
操纵方式	机械操纵。 先导液比例操纵，由左右2个操纵手柄控制。无级调速。	● 机械机型 ● 先导机型
主起升机构	液压控制调速，装有双折线绳槽卷筒，由液压马达通过行星齿轮减速器驱动，内置常闭式制动器并带有平衡阀。 具有轻载高速、重载低速的特点。	●
副起升机构	液压控制调速，装有双折线绳槽卷筒，由液压马达通过行星齿轮减速器驱动，内置常闭式制动器并带有平衡阀。 具有轻载高速、重载低速的特点。	●
回转机构	四点接触球式回转支承，由液压马达通过行星齿轮减速器驱动，可连续回转360°；具有动力控制或自由回转的功能，可无级调速。	●
变幅机构	单支双作用前置液压变幅油缸，带有平衡阀。	●

技术规格

Technical specifications

操纵室	新型钢制操纵室，装有安全玻璃，车窗装有遮阳帘，外开式车门，座椅靠背可倾斜定位。	●
	前窗顶窗装有雨刮器，标准的操纵控制件和指示器。 配备单冷空调。 操纵杆加长节	○
平衡重	固定平衡重4t，活动平衡重1.5t。	●
安全装置	液压平衡阀；液压溢流阀；力矩限制器；操纵杆弹簧式回中系统；三圈保护器，防止钢丝绳过放；臂头设置高度限位，防止钢丝绳过卷；自由滑转；回转锁止	●
	卷扬监视装置	○
	三色报警灯	○
	回转警示灯	○
	角度指示器	○
	黄色反光标识	○
		右驾机型
起重钩	60t吊钩	●
	4.5t吊钩	●
	35t吊钩	○

 臂架系统	配置	
主臂	由1节基本臂和4节伸缩臂组成，采用U形截面的筒形焊接结构、抗扭曲设计，高强度结构钢制造。单缸绳排伸缩机构。 主臂长度：11.4m~43.5m	●
侧置副臂	2节桁架式焊接结构，具有0°、15°、30°三种固定副臂安装角 固定副臂长度：9.5m/16m	●
腹置副臂	采用两节箱型腹置副臂，一节臂工作长度9.8m，两节臂全伸工作长度16m，安装角度5°、15°、30°。	○
臂端单滑轮	单滑轮，安装在主臂顶端用于单股钢丝绳起重作业，起重性能与主臂相同，但最大起重量不超过4.5t。	●

产品各部件明细如上所述，具体部件明细请参照产品报价单

符号说明：

- —— 表示标准配置；
- —— 表示选装配置。

技术规格

Technical specifications

	Chassis	
Frame	Designed and manufactured by XCMG, it is made of high strength steel with fully covered walking surface and anti-torsion box-typed structure.	●
Outriggers	Four outriggers arranged in H-shape are hydraulically controlled by control levers, with 5th jack available. There is an outrigger control station located at each side of the chassis, and there is a level gauge on each control station. The outrigger movements can be simultaneously or separately controlled at any side of the chassis. There is a check valve fitted in each outrigger cylinder, and a double-way hydraulic valve fitted in each jack cylinder. Outrigger float diameter: φ450 mm Reaction force of outrigger at max. lifting load: 410kN	●
Engine	Made by CHINA NATIONAL HEAVY DUTY TRUCK GROUP, in line, water cooled, four-stroke, supercharging, high pressure common rail; WD615.334, with rated power of 247 kW/2200 rpm and max. torque of 1350 Nm/1100-1600 rpm, compliant with China III emission standard.. Fuel tank capacity: 300L. Dongfeng Cummins Engine Co., Ltd., in line, water cooled, four-stroke, turbocharged intercooler, high pressure common rail; QSL8.9-C325-30, with rated power of 242kW/2100rpm, and the max. torque of 1385Nm/1500rpm, compliant with Stage III emission standard. Fuel tank capacity: 300L WP9H336E62, in-line, six-cylinder, water-cooled, four-stroke, supercharging, high pressure common rail engine, manufactured by Weichai Power, with rated power of 247kW/1900 rpm and max. torque of 1600Nm/(1000-1400)rpm, compliant to BS-IV emission standard. Fuel tank capacity: 320L	● Right-hand drive ○ Right-hand drive ○ Right-hand drive

Engine	Made by CHINA NATIONAL HEAVY DUTY TRUCK GROUP, in line, water cooled, four-stroke, supercharging, high pressure common rail; D10.34-50, with rated power of 249kW/1900rpm and max. torque of 1490Nm/1200-1500rpm, compliant with China V emission standard.. Fuel tank capacity: 300L.	● Left-hand drive
Transmission	Mechanical transmission, made by Shaanxi Fast Gear Co., Ltd., manual flexible shaft control; 9-forward speed and 1-reverse speed with a synchronizer.	●
Axles	High strength axles, made by famous makers through adoption of foreign advanced technology, with reliable performance.	●
Suspensions	Rubber spring suspensions with V-type push rods are adopted for rear suspension system, leading to improved chassis stability and reduced tire wear. Leaf spring suspensions with V-type push rods are adopted, leading to improved chassis stability and reduced tire wear.	● Right-hand drive ● Left-hand drive
Tires	315/80R22.5, tubeless tire, light weight, good heat dissipation, low noise during traveling, strong bearing capacity, long service life.	●
Brakes	Service braking: foot pedal operated double-circuit air pressure brake. 1st circuit acts on the wheels of 1st and 2nd axles, and 2nd circuit acts on the wheels of 3rd and 4th axles. Parking brake: spring-loaded brake, acting on wheels of axles 2,3 and 4; Auxiliary brake: engine exhaust brake, which is safe and reliable, and will prolong the service life of brake lining.	●
Steering	Mechanically steering mechanism with a hydraulic booster.	●
Driver's cab	Luxurious driver's cab. Safety glass, electrically operated door window lifters, adjustable seats, electrical adjustable mirrors, steering wheel adjustable in height and angle, liquid crystal display and radio-cassette player are equipped. Heater and air conditioner are standard.	●

技术规格

Technical specifications

Electrical system	24 V DC, two sets of 12 V battery in series.	●
	Generator: 28 ± 0.3 V-70 A (or 80A).	
Safety devices	double-way hydraulic valve,	●
	Beacon lamp	○
	backup camera	○
	ABS	○
	Yellow reflecting marking	○
		Right-hand drive

	Superstructure	
Frame	Designed and manufactured by XCMG, made of high strength steel.	●
Hydraulic system	Special throttle with LUDV load sensitive design, more stable system minimum flow, more reasonable system rigidity, more prominent fine-control and smoothness; confluence technology for lifting, elevating and telescoping double-pump confluence; air-cooled hydraulic oil cooler is fitted. Oil tank capacity: 600 L	●
Operating mode	Mechanical control.	● Mechanical
	Pilot hydraulic proportional control through left and right levers is used for controlling the superstructure. Stepless speed regulation is available.	● Pilot
Main winch system	Hydraulic control is used for speed regulation. The system is driven by a hydraulic motor through a planetary gear reducer, with a normally closed brake, balance valve and a grooved drum equipped. It has features of high speed with a light load and low speed with a heavy load.	●
Auxiliary winch system	Hydraulic control is used for speed regulation. The system is driven by a hydraulic motor through a planetary gear reducer, with a normally closed brake, a balance valve and a grooved drum equipped. It has features of high speed with a light load and low speed with a heavy load.	●
Slewing system	Four-point contact-ball slewing ring is driven by the planetary gear reducer of slewing mechanism, which is driven by a hydraulic motor, and may continuously slew 360°. Power control and free slewing function as well as stepless speed regulation are available.	●
Elevating system	A front support double-acting hydraulic cylinder is equipped for elevating operation, with a balance valve fitted.	●

技术规格

Technical specifications

Operator's cab	New steel cab. Safety glass and sun shield are used for windows. A swing-out door is equipped. The cab features a new ergonomic seat design with backrest adjustment. Wipers are fitted for the windshield and roof window; standard controls and indicators are ergonomically arranged in the cab. Air conditioner is standard. Extension of control lever	●
		○ Mechanical
Counter Weight	Fixed counterweight of 4t, Removable counterweight of 1.5 t.	●
Safety devices	Hydraulic balance valve, hydraulic relief valve, LMI, spring centering system for control levers, lowering limiter for preventing wire rope from over-releasing, and anti-two block at boom head for preventing wire rope from over-winding. Free sliding and slewing locking.	●
	Winch monitoring device	○
	tri colored light bar	○
	beacon lamp	○
	angle indicator	○
	yellow reflecting marking	○ Right-hand drive
Hook block	60t Hook block	●
	4.5t Hook block	●
	35t Hook block	○

	Boom and jib system	
Boom	Comprised of one basic boom and four telescoping boom sections, with U-shaped cross-section, welded structure and adopts anti-distortion design and is made of high strength structural steel. Single-cylinder plus ropes telescoping system. Boom length: 11.4 m~43.5 m	●
Swing-away jib	Two-section lattice jib, welded structure; three offset angles of 0°, 15° and 30°. Fixed jib length: 9.5m/16m.	●
Under lung jib	Two-section box-type jib is stowed under boom. One jib section is 9.8 m, the total length of two jib sections is 16 m. The jib has offset angles of 5° , 15° and 30° .	○ Right-hand drive
Single top	Fitted at boom head, used for single line operation. Its lifting performance is the same as that for boom, but the maximum lifting load does not exceed 4.5t.	●

Product parts list is as mentioned above. Please refer to the product quotation for specific parts.

Symbol explanation:

- —it means the standard configuration;
- —it means the optional configuration.

重量 Weight





车桥 Axle	1	2	3	4	总重量 Total weight
t	8.5	8.5	11.55	11.55	40.1







吊钩 Hook	倍率 No. of lines	吊钩重量 Weight (kg)	吊钩尺寸 Dimensions (mm)	备注 Remarks
60t	12	517	1325×544×537	单钩 Single hook, 标配 Standard
35t	10	403	1334×544×419	单钩 Single hook, 选装 optional
4.5t	1	100(侧置副臂 Swing-away jib) /70(腹置副臂 Under lung jib)	536×298×298 /920×240×240	单钩 Single hook, 标配 Standard

作业速度 Working speeds



		
315/80R22.5	2~90	40%



作业机构 Drive	作业速度 Working speed	最大单绳拉力 Max. single line pull	钢丝绳直径/长度 Rope diameter/ length
	0-128 m/min, 单绳, 第四层 m/min, single line, 4th layer	45 kN	18 mm/190m
	0-128 m/min, 单绳, 第四层 m/min, single line, 4th layer	45 kN	18mm/125m
	0-2r/min		
	从-1°抬起至81°约40s Approx. 40s for boom elevation from -1° to 81°		
	从11.4m伸出至43.5m约90s Approx. 90s for boom extension from 11.4m to 43.5m		

臂架组合方案

Boom / Jib combinations



主臂
Telescopic boom

T: 11.4~43.5m

副臂
Jib

T: 43.5m

J: 9.5m/16m(侧置副臂 Swing-away jib)

J: 9.8m/16m(腹置副臂 Under lung jib)

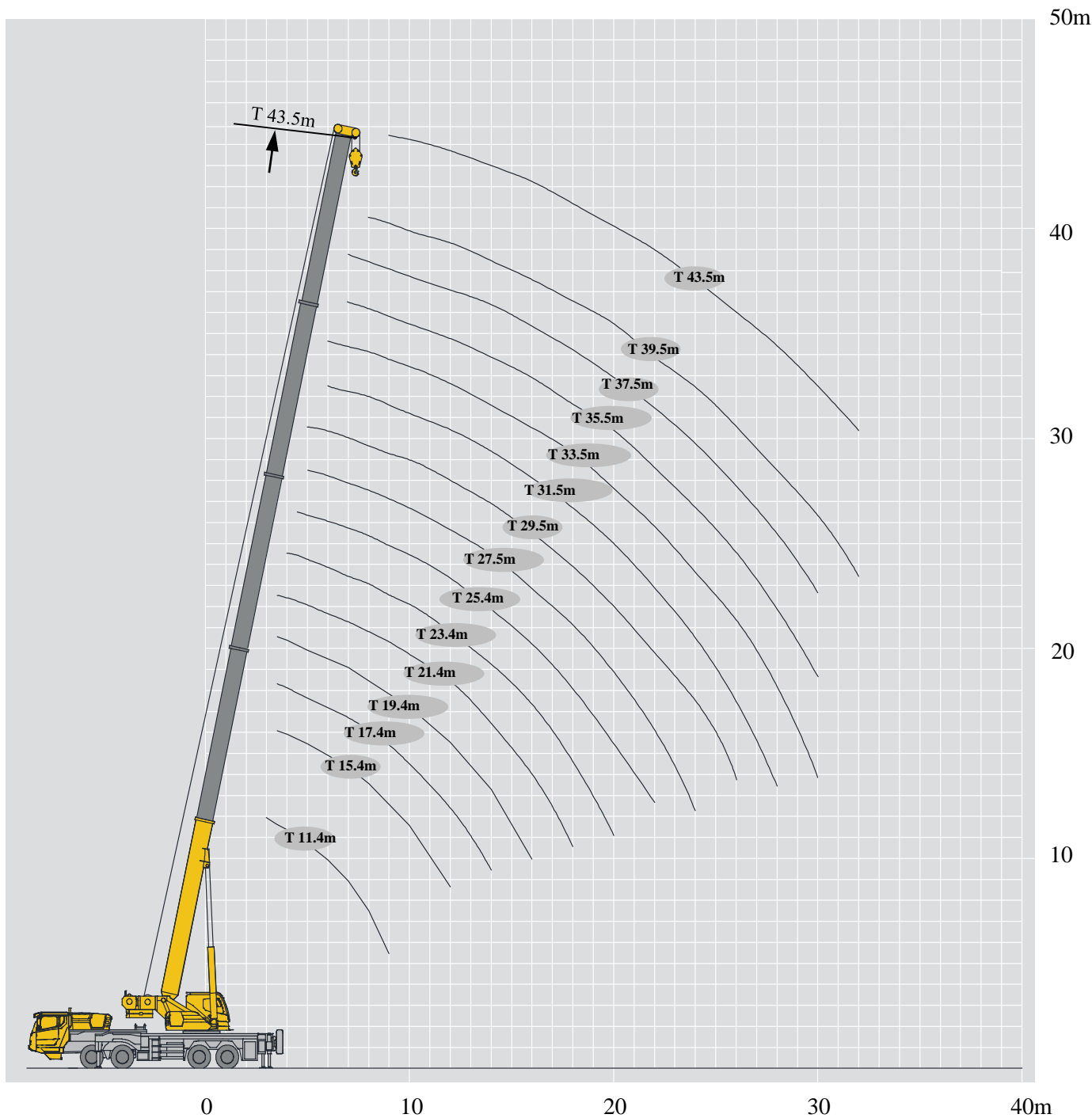



起重性能表

Lifting capacities

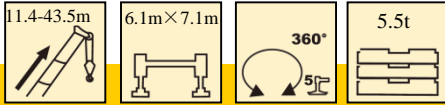
T 11.4~43.5m



 m	11.4m	15.4m	19.4m	25.4m	31.5m	37.5m	43.5m	 m
3	50000	45000						3
3.5	50000	45000						3.5
4	48000	45000	35000	25000				4
4.5	45000	42900	32100	25000				4.5
5	41000	39600	29900	25000	18500			5
5.5	36500	36000	28100	24000	18500			5.5
6	33000	32500	26300	22700	18100			6
7	28000	27600	23400	20300	16600	13100		7
8	21300	21000	20800	18300	15200	12300	9000	8
9	16900	16600	16400	17500	14100	11500	8500	9
10		13300	13100	14200	13000	10700	8200	10
12		9000	8800	9800	10500	9400	7500	12
14			6200	7100	7700	8100	6800	14
16			4400	5300	5800	6200	6000	16
18				3900	4500	4800	5100	18
20				2900	3500	3800	4100	20
22				2100	2700	3000	3300	22
24					2000	2400	2600	24
26					1500	1800	2100	26
28						1400	1600	28
30						1000	1200	30
32							900	32

起重性能表

T 17.4~39.5m

Lifting capacities

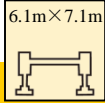

m	17.4m	23.4m	29.5m	35.5m	21.4m	27.5m	33.5m	39.5m	m
3	27000								3
3.5	27000				27000				3.5
4	27000	27000			27000				4
4.5	27000	25700			27000				4.5
5	27000	24700	16600		27000	24000			5
5.5	27000	23750	15800		27000	24000			5.5
6	27000	22800	15000	11600	27000	23400	14800		6
7	27000	21200	13600	10800	27000	21900	13700	10100	7
8	22900	19800	12400	10000	22300	20600	12800	9600	8
9	18400	19100	11300	9300	17900	18600	11900	9100	9
10	15100	15800	10500	8700	14600	15300	11000	8600	10
12	10700	11300	9100	7500	10200	10800	9600	7700	12
14	7900	8500	7900	6500	7400	8000	8400	6800	14
16		6600	6900	5800	5600	6200	6500	6000	16
18		5200	5500	5200	4200	4800	5200	5100	18
20			4500	4700		3800	4100	4300	20
22			3700	3900		3000	3300	3500	22
24			3000	3200			2600	2900	24
26				2600			2100	2300	26
28				2200			1600	1900	28
30				1800				1500	30
32								1200	32
34								900	34

起升高度曲线图 Lifting heights



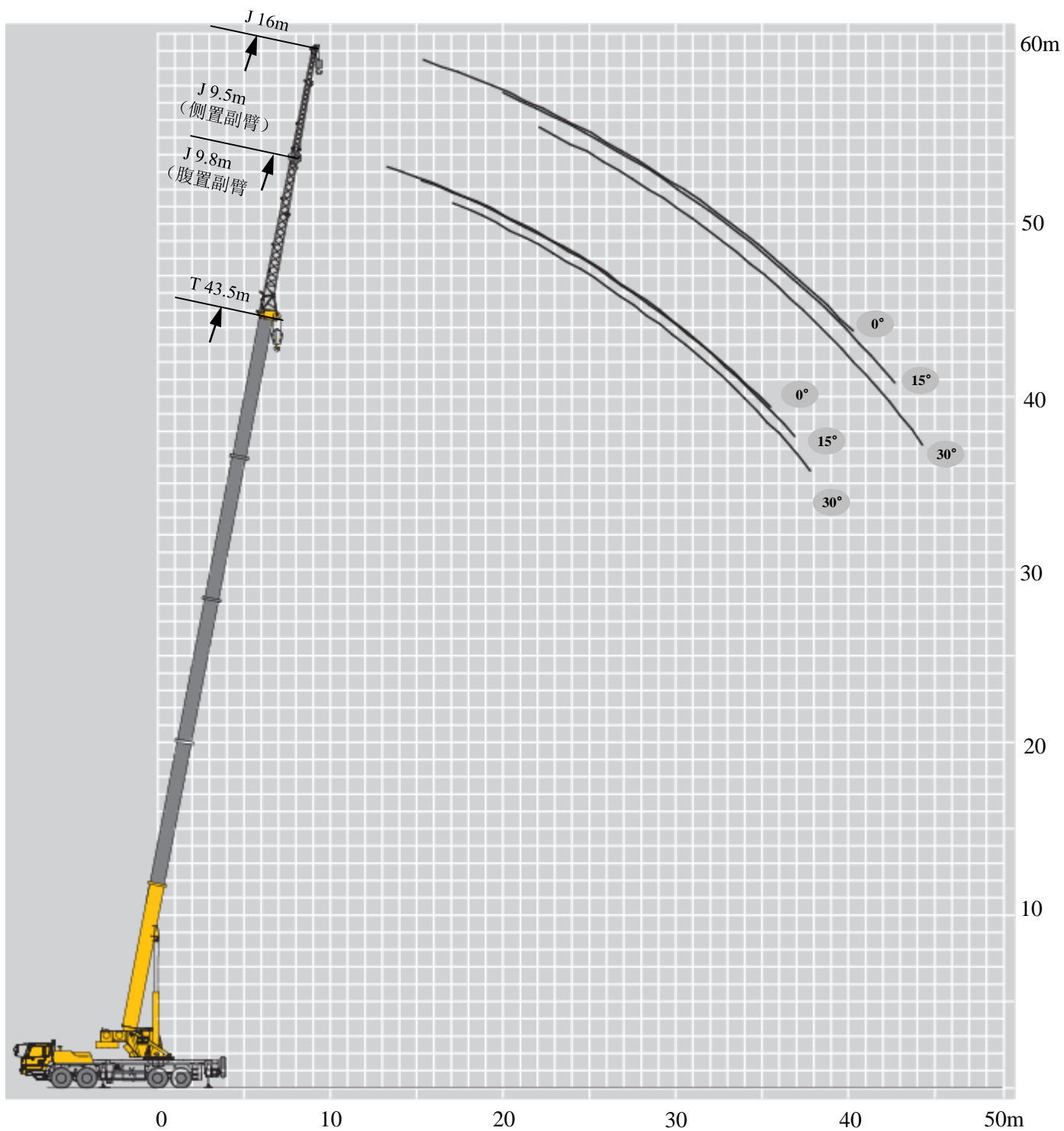

副臂
Jib





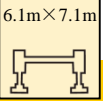

起重性能表

Lifting capacities

T 43.5m

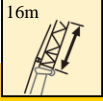
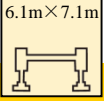
	   				
	0° /5° (腹置副臂 Under lung jib)	15°	30°		
78	4500	3000	2500	78	
75	4100	2800	2400	75	
72	3800	2600	2300	72	
70	3500	2500	2200	70	
65	2300	2100	1900	65	
60	1400	1300	1200	60	
55	800	800	700	55	
50	400	400	300	50	

	   				
	0° /5° (腹置副臂 Under lung jib)	15°	30°		
78	2800	1500	1200	78	
75	2400	1400	1100	75	
72	2000	1200	1000	72	
70	1900	1200	950	70	
65	1700	1000	850	65	
60	1000	900	750	60	
55	500	400	400	55	
50	100	100	100	50	

注意事项

Notes

1. 表中额定总起重量值，是在平整的坚固地面上本起重机能够保证的最大总起重量，包括吊钩和吊具的重量，所以为了估算重物重量，必须减去上述的装置重量。
2. 表中的工作幅度为起吊重物离地时起重物到起重机回转轴线的水平距离，是包括起重臂变形量在内的实际值，因而起吊前应考虑起重臂变形量。
3. 只允许在5级(瞬时风速14.1m/s，风压125N/m²)风以下进行作业。
4. 吊重前操作者必须对物体的重量和工作范围了解后选择合适的作业工况，严禁超出表中的数值。幅度及臂长在相邻两个数值之间时，应依据两个数值中较小值确定起重作业。
5. 应按主臂仰角范围作业，即使是空载，也不应使主臂仰角处于范围外，谨防整机倾翻。
6. 表中的主臂长度应要按照每节臂的伸缩要求进行伸出。

1. The total rated loads given in the rated load charts are the maximum lifting capacity when the crane is set up on firm and level ground, which includes the weight of the hook block and slings. The weight of above-mentioned devices should be deducted from the rated lifting load.
2. The working radius shown in the rated load charts is the radius when the load is lifted off the ground, and it is the actual value including loaded boom deflection. Take boom deflection into consideration before beginning a lifting operation.
3. A lifting operation is permissible only when the wind force is below grade 5 (instantaneous wind speed is 14.1 m/s, wind pressure is 125 N/m²).
4. Before beginning lifting operation, the operator should know the weight of the load to be lifted and its working range, and then select proper working conditions. Never operate the crane beyond the limit shown in the chart. Use the lower value from the chart when the boom length or working radius is between the range of values.
5. Observe the boom angle limit. Never operate the crane with the boom angle beyond the recommended limit even if a load is not being carried. Otherwise, the crane will tip.
6. The boom should be extended according to the telescoping code shown by percentage (or digits, which means the percentage of boom sections extended).

符号标识

Description of symbols

常规标识

General symbols

	上车 Superstructure		底盘 Chassis
	起重能力 Lifting capacity		车桥 Axle
	吊臂长度 Boom length		行驶速度 Driving speed
	工作幅度 Radius		爬坡能力 Grade ability
	吊臂仰角 Boom angle		轮胎 Tires
	主臂起升高度 Hoist height with boom		支腿 Outriggers
	固定副臂长度 Fixed jib length		吊钩 Hook block
	副臂安装角 Jib offset angle		平衡重 Counterweight
	副臂起升高度 Hoist height with jib		卷扬 Winch
	使用第五支腿360°全回转 360° operation of the boom with 5th jack down		360°全回转 360° operation of the boom

主要技术参数表

Table of main technical parameters

类别 Category	项目 Item	单位 Unit	参数 Parameter			
			右驾 Right-hand drive		左驾 Left-hand drive	
尺寸参数 Dimensions	外形尺寸 (长×宽×高) Dimensions (length×width×height)	mm	14045×2790×3615 (侧置副臂 Swing-away jib)		14045×2790×3615 5	
			14600×2790×4050 (腹置副臂 Under lung jib)			
	轴距 Wheel base	mm	1470+4300+1350		1470+4300+1350	
	轮距 (前/后) Track (Front/ Rear)	mm	2304/2081		2304/2079	
	前悬/后悬 Front/ Rear overhang	mm	2376/2404		2376/2404	
重量参数 Weight	最大允许总质量 Total vehicle mass in travel configuration		kg	40100		40100
	轴荷 Axle load	一轴 1st axle	kg	8500		8500
		二轴 2nd axle	kg	8500		8500
		三轴 3rd axle	kg	11550		11550
		四轴 4rd axle	kg	11550		11550
动力参数 Power	发动机型号 Engine model		—	WD615.334	QSL8.9-C325-30	WP9H336E62
	额定功率/转速 Rated power/rpm		kW/(r/min)	247/2200	242/2100	247/1900
	最大净功率/转速 Max. net power/rpm		kW/(r/min)	245/2200	--	242/1900
	最大输出扭矩/转速 Max. output torque/rpm		N.m/(r/min)	1350/1100-1600	1385/1500	1600/1000-1400
行驶参数 Travel	最高车速 Max. travel speed		km/h	≥90	≥50	≥48
	最低稳定车速 Min. stable travel speed		km/h	2~3		2~3
	最小转弯直径 Min. turning diameter		m	≤24		≤24
	臂头最小转弯直径 Min. turning diameter at boom tip		m	≤30.2 (侧置副臂 Swing-away jib)		≤30.2
				≤30.24 (腹置副臂 Under lung jib)		
	最小离地间隙 Min. ground clearance		mm	260		260
	接近角 Approach angle		°	19		19
	离去角 Departure angle		°	13		13
	制动距离 (制动初速度为30km/h) Braking distance (at 30 km/h)		m	≤10		≤10
	最大爬坡能力 Max. grade ability		%	≥40		≥40
百公里油耗 Fuel consumption per 100 km		L	38		38	
噪音 Noise	加速行驶机外噪声 Exterior noise level		dB(A)	≤84		≤84
	驾驶员耳旁噪声 Noise level at seated position		dB(A)	≤90		≤90

主要技术参数表

Table of main technical parameters

类别 Category	项目 Item	单位 Unit	参数 Parameter			
			右驾 Right-hand drive	左驾 Left-hand drive		
主要性能参数 Main performance	最大额定总起重量 Max. total rated lifting capacity	t	50	50		
	最小额定工作幅度 Min. rated working radius	m	3	3		
	转台尾部回转半径 Turning radius at turntable tail	mm	3800	3800		
	最大起重力矩 Max. load moment	基本臂 Base boom	kN.m	2009	2009	
		最长主臂 Fully-extended boom	kN.m	933	933	
		最长主臂+副臂 Fully-extended boom + Jib	kN.m	696	696	
	支腿跨距 Outrigger span	纵向 Longitudinal	m	6.1	6.1	
		横向 Lateral	m	7.1	7.1	
	起升高度 Hoist height	基本臂 Base boom	m	11.2	11.2	
		最长主臂 Fully-extended boom	m	43.3	43.3	
		最长主臂+副臂 Fully-extended boom + Jib	m	59.5	59.5	
	起重臂长度 Boom length	基本臂 Base boom	m	11.4	11.4	
		最长主臂 Fully-extended boom	m	43.5	43.5	
		最长主臂+副臂 Fully-extended boom + Jib	m	59.5	59.5	
副臂安装角 Jib offset angle		°	0, 15, 30 (侧置副臂 Swing-away jib)	0, 15, 30		
			5, 15, 30 (腹置副臂 Under slung jib)			
工作速度参数 Working speed	起重臂起臂时间 Boom raising time		s	≤40	≤40	
	起重臂全伸时间 Boom fully extending time		s	≤90	≤90	
	最大回转速度 Max. slewing speed		r/min	≥2	≥2	
	支腿收放时间 Outrigger extending and retracting time	水平支腿 Outrigger beam	收 Retracting	s	≤30	≤35
			放 Extending	s	≤30	≤40
		垂直支腿 Outrigger jack	收 Retracting	s	≤35	≤35
			放 Extending	s	≤40	≤40
	起升速度 (单绳, 第四层, 空载) Hoisting speed (single line, 4th layer, no load)	主起升机构 Main winch	m/min	≥128	≥128	
副起升机构 Auxiliary winch		m/min	≥128	≥128		
噪声 Noise	机外辐射 Exterior noise level		dB (A)	≤122	≤122	
	司机位置处 Noise level at seated position		dB (A)	≤90	≤90	



地址: 江苏省徐州市经济技术开发区高新路68号
Add: No. 68 Gaoxin Road,
Economic and Technological Development Zone,
Xuzhou, Jiangsu, China
电话(Tel): +86-516-83462242/83462350
质量监督电话(Quality Inquiry Tel): +86-516-
87888268
备件电话(Spare Parts Tel): +86-516-83461542
邮编(Post Code): 221004
网址(Web): www.xcmg.com/qizhongji

服务热线 Service Tel

400-110-9999

400-001-5678



本印刷品不属于合同。出于产品不断改进的需要，我们保留对产品型号、参数、配置进行变更的权利，恕不另行通知。图片仅供参考，具体产品以实物为准。图片中产品可能并非标准配置，部分部件可能需要另行购置。办理牌照和上路行驶需遵守当地法规。

This print does not belong to the contract. We reserve the right to modify the design (such as product model, parameters and configuration) without notice for improvement. The pictures are just for reference. The product in the picture may not be standard configuration. Some parts need to be purchased separately. Conform to the local laws for license application and road traveling.