



SCC450A

Crawler Crane

45 Tons Lifting Capacity

Quality Changes the World



Max. lifting moment: 150t·m
Max. boom length: 40m
Max. fixed jib combination: 31m+15.25m

The parameters and diagrams in the brochure is only for reference, which is subject to further update in real machine.

■ www.sany.com.cn

Crawler Crane Series
SCC450A

P03

Main
Characteristics

- Product Specification
- Safety Device

P09

Technical
Parameters

- Major Performance & Specifications
- Outline Dimension
- Transport Dimension
- Transport Plan

P16

Cofigurations

- H Configuration
- FJ Configuration



SCC450A
SANY CRAWLER CRANE
45 TONS LIFTING CAPACITY

QUALITY CHANGES THE WORLD

Main Characteristics

- Page 04 Product Specification
- Page 07 Safety Device



Product Specification



Engine (Standard Offering)

- Model: DCEC (Cummins China) QSB5.9-C210 Diesel Engine;
- Type: 4-stroke, water-cooled, vertical in-line 6 cylinders, direct injection, turbo-charger, intercooler, complied with European Off-way Tier III Emission Standard and Chinese Off-way Tier III Emission Standard;
- Displacement: 5.9L;
- Rated power: 154kW/2200rpm;
- Operation power: 147kW/1800rpm;
- Max. Torque: 820N·m/1500rpm;
- Starter: 24V-6.0kW.

Electrical Control System

- Self-developed SYIC-II integrated control system is adopted with higher integration, precise operation and reliable quality;
- Control system consists of power system, engine system, main control system, LMI system, auxiliary system and safety monitoring system. CAN BUS is used for data communication between controller, monitor and the engine;
- Monitor: the working parameters and status are shown on the monitor, such as the engine speed, fuel volume, engine oil pressure, servo pressure, wind speed, engine working hours, lifting conditions and boom angle.

Hydraulic System

- Main pumps: open variable displacement piston pumps are adopted to provide oil supply for main actuators of main machine;
- Gear pump: dual-gear pump for swing and control circuit;
- Control: main pump adopts positive flow proportional control; main load winch motor adopt piston motor of variable displacement; aux. load winch and boom hoist winch motor adopts piston motor of fix displacement. The operating components adopt two cross hydraulic handles, one dual travel pedal control valve, to control various actuators proportionally;
- Way of cooling: heat exchanger, fan core and multi-stage cooling;
- Filter: large flow, high precision filter, with bypass valve and transmitter, which can remind the user to replace the filter element in time;
- Max. pressure of system: 32MPa;
- Main/aux. load hoist, boom hoist and travel system: 32MPa;
- Swing system: 24MPa;
- Control system: 5MPa;
- Hydraulic Tank Capacity:305L.

Main and Aux. Load Hoist Mechanism

- Main and aux. hoist winches are driven separately by motor via gearbox. Operating winch handle can control the winch to rotate to two directions, which are lifting and lowering of hook. Excellent inching function is equipped on the machine;
- Drums with fold-line grooves can ensure the wire rope reeved in order in multilayers;
- Standard free fall for Main load hoist, no free fall for aux. load hoist.

Main Load Hoist Mechanism	Drum diameter	449mm
	1st layer rope speed	0~75m/min
	Wire rope diameter	16mm
	Wire rope length of main load hoist	180m
	Rated single line pull	5t
Auxiliary Load Hoist Mechanism	Drum diameter	406mm
	1st layer rope speed	0~100m/min
	Wire rope diameter	16mm
	Wire rope length of auxiliary load hoist	100m
	Rated single line pull	5t



Product Specification

Boom Hoist Mechanism

- Boom hoist winches are driven separately by motor via gearbox. Operating winch handle can control the winch to rotate to two directions, which are lifting and lowering of boom;
- Drums with fold-line grooves can ensure the wire rope reeved in order in multilayers.

Boom hoist mechanism	Drum diameter	290mm
	Single rope speed	0~60m/min
	Wire rope diameter	16mm
	Wire rope length of boom hoist	95m
	Rated single line pull	3.7t

Swing Mechanism

- Swing brake adopts wet, spring loaded, normally-closed brake, and braking through spring force;
- Swing system has three work modes to accommodate different needs. It is featured in small backlash, steady control, and excellent inching function. It also has free slipping function and swing control on slope to avoid sudden braking;
- Swing drive: external engaged swing drive with 360° swing range, and the max. swing speed is 2.5rpm;
- Swing lock: cylinder lock can ensure the upperworks locked securely on four directions after work or during transport;
- Swing ring: single row ball bearing.

Cab and Control

- Novel operator's cab with fashionable profile and nice interior. There are low and high-beam lights, back-view mirror, heater and A/C, radio and other functions. The layout of seat, handles, control buttons are designed with ergonomic principles to make operation more comfortable;
- Cab layout: Integrated 8.4-inch touch screen, programmable smart switches, vibration handles are offered as optional and man-machine interaction interface are more perfect;
- Armrest box: on the left and right armrest box are control handles, electrical switches, emergent stop and ignition switch. The armrest box can be adjusted along with the seat;
- Seat: multi-way and multi-level floating adjustable seat with unload switch;
- A/C: cool and heat air; optimized air channels and vents;
- Multiple cameras can present on the monitor at the same time to realize real-time monitoring of machine traveling, right crawler, conditions behind the counterweight and surrounding the machine.

Counterweight

- Counterweight tray and blocks are in stack for easier assembly and transport;
- Total rear counterweight: approximately 10t;
- Rear counterweight: counterweight tray 5.5t × 1, counterweight block 4.5t × 1.

Upperworks

- High-strength steel weld framework, with no torsion or deformation. The parts are laid out in the way that is easier for maintenance and service.

Product Specification



Lowerworks

- Independent travel driving units are adopted for each side of the crawler, to realize straight walking and turning driven by travel motor through gearbox and drive wheel;
- Travel Speed: both high and low speed are set, and the highest speed is 2km/h;
- Gradeability: 40%.

Travel brake

- Concealed wet type and spring-loaded type normally engaged brake, spring force braking, oil pressure released.

Crawler Extension and Retraction

- The crawlers can extend and retract via cylinders. During Work Mode, the crawlers must be extended, and be retracted during transport with crawlers on.

Crawler tensioning

- Spring tensioner with auxiliary hydraulic cylinder regulates the tension degree through charging grease, and the spring can perform buffer and protection function when traveling.

Steering system

- It can realize single track turning and pivot turning.

Track shoe

- Excavator three-reinforcement chain link track shoe is adopted, which is made of high strength alloy cast steel, has stronger road holding capacity and longer service life, and can adapt to various harsh road conditions.. Width 700mm, Qty 60x2.

Track roller

- Maintenance-free track roller.

Operating Equipment

- All chords are high-strength steel tubes, and the boom/jib top sheaves are made of high-strength anti-wearing Nylon material protecting wire rope. The hooks are installed with milled welded steel sheave.

Boom

- Lattice structure. The chord adopts high-strength structural tube and each section is connected through pins;
- Basic boom: 5m boom top + 5m boom base ;
- Boom insert: 3m×2, 6m×1,9m×2;
- Boom length: 10m~40m.

Fixed Jib

- Lattice structure. The chord adopts high-strength structural tube and each section is connected through pins;
- Basic boom: 3.05m jib top + 3.05m jib base;
- Boom insert: 3.05m x 3;
- Jib length: 6.1m~15.25m;
- Longest boom + jib: 31m boom +15.25m jib.

Extension Jib

- The extension jib is a welded structure connected to the boom top by pins, used for auxiliary hook;
- Extension jib length: 0.8m.

Hook Block

- 45t hook block, five sheaves;
- 5t ball hook.



Safety Device

Assembly Mode/Work Mode Switch

- In Assembly Mode, certain safety devices are disabled to facilitate crane assembly;
- In Work Mode, all safety devices activate to protect the operation.

Emergent Stop

- In emergent situation, this button is pressed down to cut off the power supply of the whole machine and all actions stop.

Load Moment Indicator (LMI)

- It is an independent computerized safety control system. LMI can automatically detect the load weight, work radius and boom angle, and present on the display the rated load, actual load, work radius and boom angle. In normal operation, the LMI can make a judgment and cut off automatically if the crane moves towards dangerous direction. It can also perform as a black box to record the lifting information;
- It is composed of monitor, angle sensor, force sensor and other parts.

Over-hoist Protection of the Main/ Auxiliary Load Hoist

- Over-hoist protection device comprises limit switch and weight on boom top, which prevents the hook lifting up too much. When the hook lifts up to the limit height, the limit switch activates, buzzer on the right control panel sends alarm, failure indicator light starts to flash and the hook hoisting action is cut off automatically.

Over-release Protection Device of the Main/Auxiliary Load Hoist

- It is comprised of activator in the drum and proximity switch to prevent over release of wire rope. When the rope is paid out close to the last three wraps, the proximity switch acts, and the system sends alarm through buzzer and show the alarm on the monitor, automatically cutting off the winch action.

Function Lock

- If the function lock level is not in work position, all the other handles won't work, which prevents any mis-operation caused by accidental collision.

Boom Hoist Drum Lock

- Hydraulically controlled lock is installed for boom hoist drum, which needs to unlock by switch before operation, in order to prevent mis-operation of handles and ensure safety during non-work time.

Swing Lock

- Swing Lock can lock the machine.

Boom Limit Device

- When the boom elevation angle reaches the upper limit, the buzzer sounds and boom action is cut off. This protection is two-stage control ensured by both LMI system and travel switch.

Back-stop Device

- Its major components are nesting tubes and spring, in order to buffer the boom backlash and prevent further tipping back.

Boom Angle Indicator

- Pendulum angle indicator is fixed on the side of boom base close to the cab, so as to provide convenience to the operator.

Hook Latch

- The lifting hook is installed with a baffle plate to prevent wire rope from falling off.

Safety Device



Tri-color Load Indicator

- The load indication light has three colors, green, yellow and red, and the real time load status is presented on the display. When the actual load is smaller than 90% of rated load, the green light is on; when the actual load is larger than 90% and smaller than 100%, the yellow light is on, the alarm light flashes and sends out intermittent sirens; when the actual load reaches 100% of rated load, the red light is on, the alarm light flashes and sends out continuous sirens. At this moment, the system will automatically cut off the crane's dangerous operation.

Alarm Light

- When the machine is powered on, the alarm light will work when time comes, so as to warn people around.

Swing Indicator Light

- The swing indicator light flashes during traveling or swing.

Illuminating Light

- The machine is equipped with short-beam light in front of machine, front angle adjustable far-beam light, lamps in operator's cab, lighting devices for night operation, so as to increase the visibility during work.

Rearview Mirror

- It is installed on the left of the operator's cab and at the front handrail of the sheet metal for monitoring the rear part of the machine.

Pharos

- Pharos is mounted on the top of boom/jib to indicate the height.

Anemometer

- It is mounted on the top of boom/jib, and displayed on the monitor in the cab.

Electronic Level Gauge

- It displays the tipping angle of crane on the monitor in real time and sends out alarm to the operator automatically when the angle is out of limit.

Seat Interlock

- If the operator leaves the seat, all control handles will be locked immediately to prevent any mis-operation due to accidental collision.

Engine Power Limit Load Adjustment and Stalling Protection

- The controller monitors the engine power to prevent engine getting stuck and stalling.

Engine Status Monitoring

- The engine status will be presented, such as engine coolant temperature, fuel volume, total work hours, engine oil pressure, engine speed, battery charging and voltage.

Monitoring System

- Remote Monitoring system is a standardized offering to provide functions like GPS locating, GPRS data transfer, machine status inquiry and statistics, operating data monitoring and analysis, remote diagnosis of failures. This function needs a local 4G sim card.



SCC450A
SANY CRAWLER CRANE
45 TONS LIFTING CAPACITY

QUALITY CHANGES THE WORLD

Technical Parameters

- Page 10 Major Performance & Specifications
- Page 11 Outline Dimension
- Page 12 Transport Dimension
- Page 15 Transport Plan

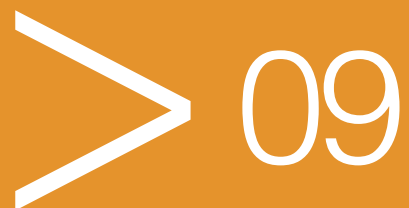

Major Performance & Specifications

Major Performance & Specifications of SCC450A			
Performance Indicators		Unit	Parameter
Boom Configuration	Max. rated lifting capacity	t	45
	Largest lifting moment	t·m	150
	Boom length	m	10~40
Fixed Jib	Max. rated lifting capacity	t	5
	Jib length	m	6.1~15.25
	Longest boom + jib	m	31+15.25
Speed	Rope speed of main/aux. winch (1st layer)	m/min	0~75
	Rope speed of boom hoist winch	m/min	0~100
	Swing speed	rpm	0~2.5
	Travel speed	km/h	0~2
Wire rope	Main load hoist wire rope: diameter × length	φ mm × m	16×180
	Aux. load hoist wire rope: diameter × length	φ mm × m	16×100
	Rated single line pull of main/aux. hoist wire rope	t	5
Engine	Model/Displacement	\L	DCEC QSB5.9-C210
	Rated power/revolution speed	kW/ rpm	154/2200
Transport Parameters	Weight of machine with basic boom	t	36
	Rear counterweight	t	10
	Transport weight of basic machine (with crawlers and boom base)	t	25.2
	Machine transport dimension (with crawlers and boom base) L×W×H	mm	10620x3000x3300
Other specifications	Average ground pressure (basic boom)	MPa	0.051
	Gradeability	%	40

Unit: mm

Outline Dimension

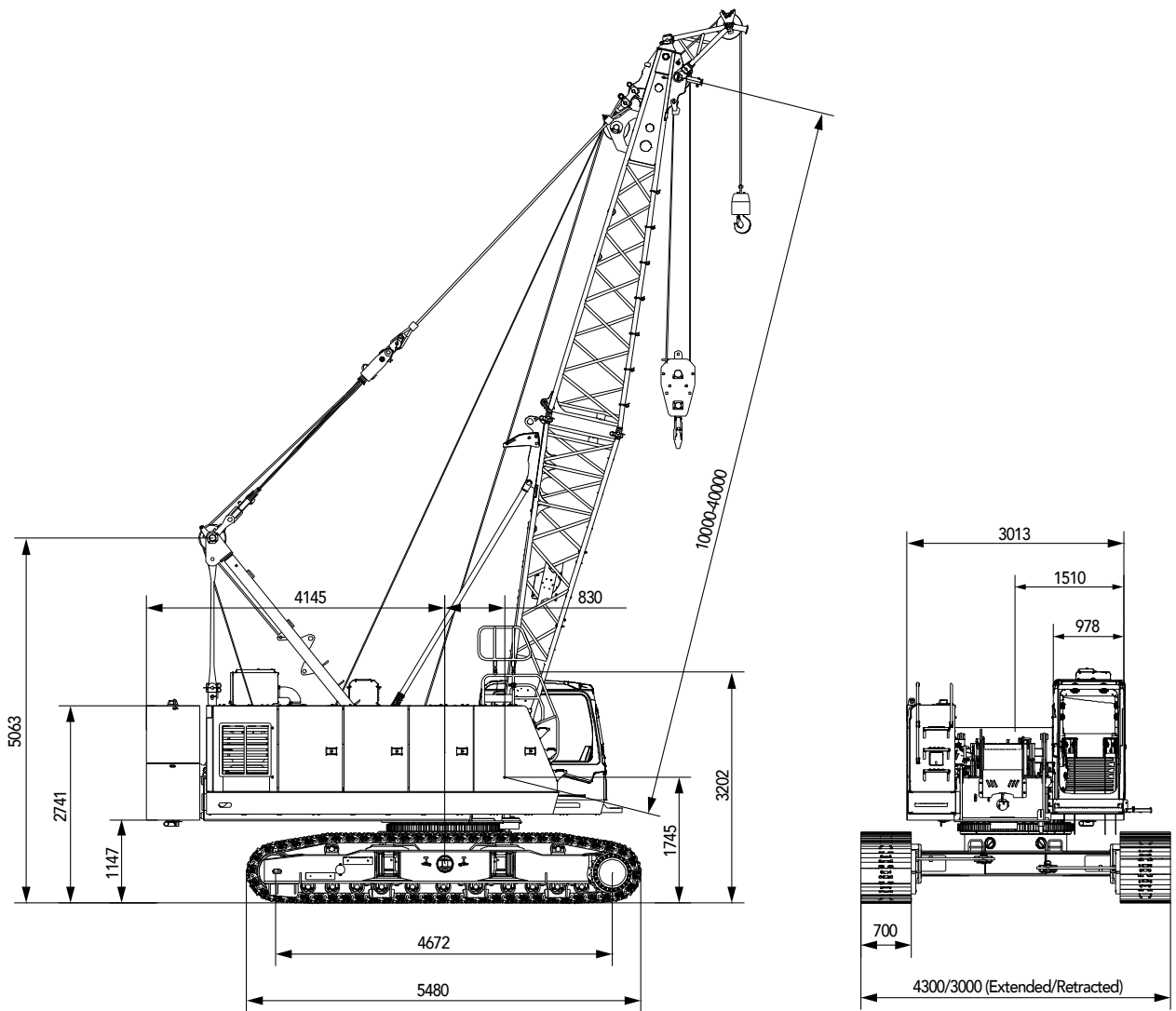

Transport Dimension

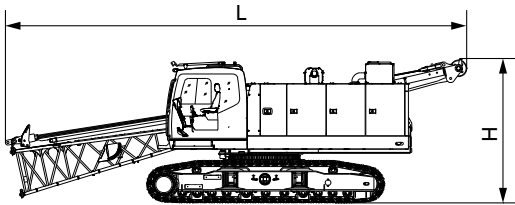

Basic Machine Mode 1 ×1

Length (L)	10.6m
Width (w)	3.0m
Height (H)	3.32m
Weight	25.2t

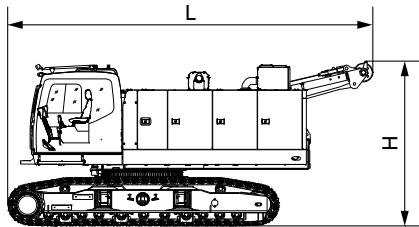

Basic Machine Mode 2 ×1

Length (L)	7.37m
Width (w)	3.0m
Height (H)	3.32m
Weight	24.4t

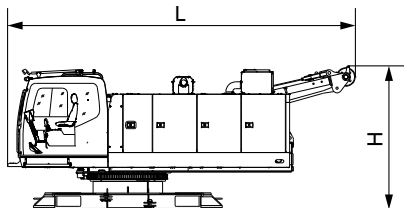

Basic Machine Mode 3 ×1

Length (L)	7.1m
Width (w)	3.0m
Height (H)	2.95m
Weight	14.4t

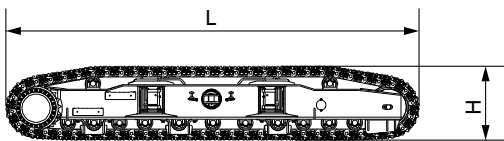

Track frame ×2

Length (L)	5.48m
Width (w)	0.83m
Height (H)	0.98m
Weight	5t

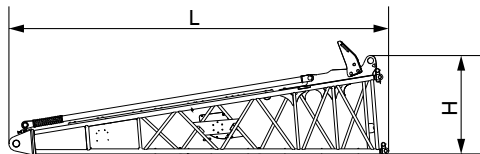

Boom base ×1

Length (L)	5.16m
Width (w)	1.44m
Height (H)	1.33m
Weight	0.74t

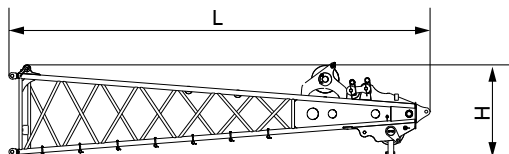

Boom top ×1

Length (L)	5.56m
Width (w)	1.31m
Height (H)	1.2m
Weight	0.53t

Transport Dimension

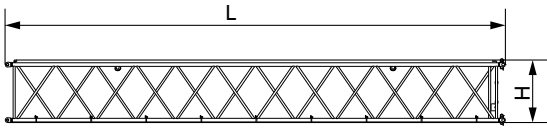

9m boom × 2

Length (L)	9.1m
Width (w)	1.27m
Height (H)	1.13m
Weight	0.44t

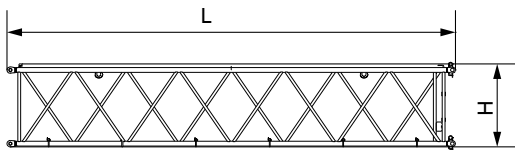

6m boom × 1

Length (L)	6.1m
Width (w)	1.27m
Height (H)	1.13m
Weight	0.31t

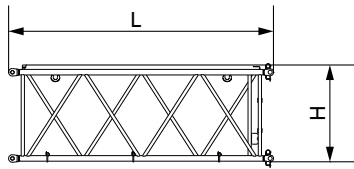

3m boom × 2

Length (L)	3.1 m
Width (w)	1.27m
Height (H)	1.13m
Weight	0.18t

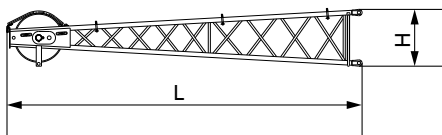

Fixed jib top × 1

Length (L)	3.38m
Width (w)	0.7m
Height (H)	0.55m
Weight	0.15t

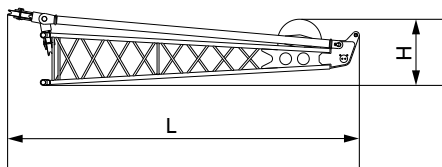

Fixed jib base and strut × 1

Length (L)	3.57m
Width (w)	0.61m
Height (H)	0.78m
Weight	0.25t

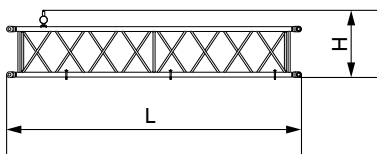

3.05m fixed jib × 3

Length (L)	3.11m
Width (w)	0.62m
Height (H)	0.7m
Weight	0.1t

Transport Dimension

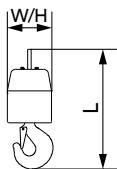
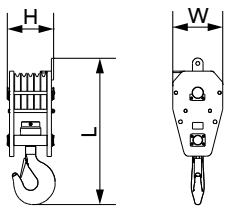
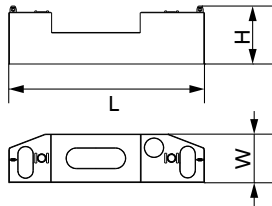
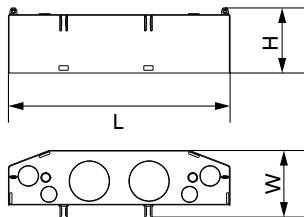
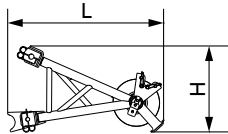

Extension jib ×1

Length (L)	1.2m
Width (w)	0.72m
Height (H)	0.66m
Weight	0.1t

Counterweight tray ×1

Length (L)	3m
Width (w)	0.9m
Height (H)	0.89m
Weight	5.5t

Counterweight block ×1

Length (L)	3m
Width (w)	0.75m
Height (H)	0.89m
Weight	4.5t

45T Hook ×1

Length (L)	1.36m
Width (w)	0.47m
Height (H)	0.43m
Weight	0.4t

5T Ball Hook ×1

Length (L)	0.66 m
Width (w)	0.24m
Height (H)	0.24m
Weight	0.08t

Note:

- 1.The transport dimensions of each part in the table are schematic, not proportional to the real parts. The dimensions are designed value without package considered.
- 2.The Weight is designed value that the actual manufactured part may deviate a little.

Transport Plan

Trailer 1	
Part(s)	▪ Basic Machine
Weight	▪ 25.2t

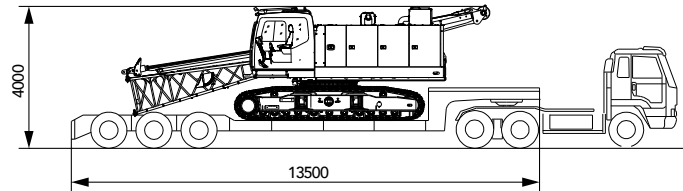

Trailer 2	
Part(s)	<ul style="list-style-type: none"> ▪ 9m boom ×2 ▪ 6m boom ×1 ▪ 3m boom ×2 ▪ Boom top ×1 ▪ Extension jib ×1 ▪ 3.05m fixed jib ×3 ▪ Fixed jib base and strut ×1 ▪ Fixed jib top ▪ 45t hook ×1 ▪ 5t hook ×1 ▪ Counterweight block ×1 ▪ Counterweight tray ×1
Weight	▪ 13.4t

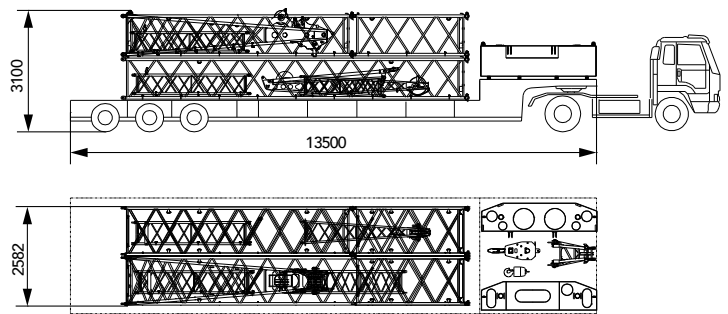



SCC450A
SANY CRAWLER CRANE
45 TONS LIFTING CAPACITY

QUALITY CHANGES THE WORLD

Boom Combination

- Page 18 H Configuration
- Page 21 FJ Configuration

> 16

Boom Combination

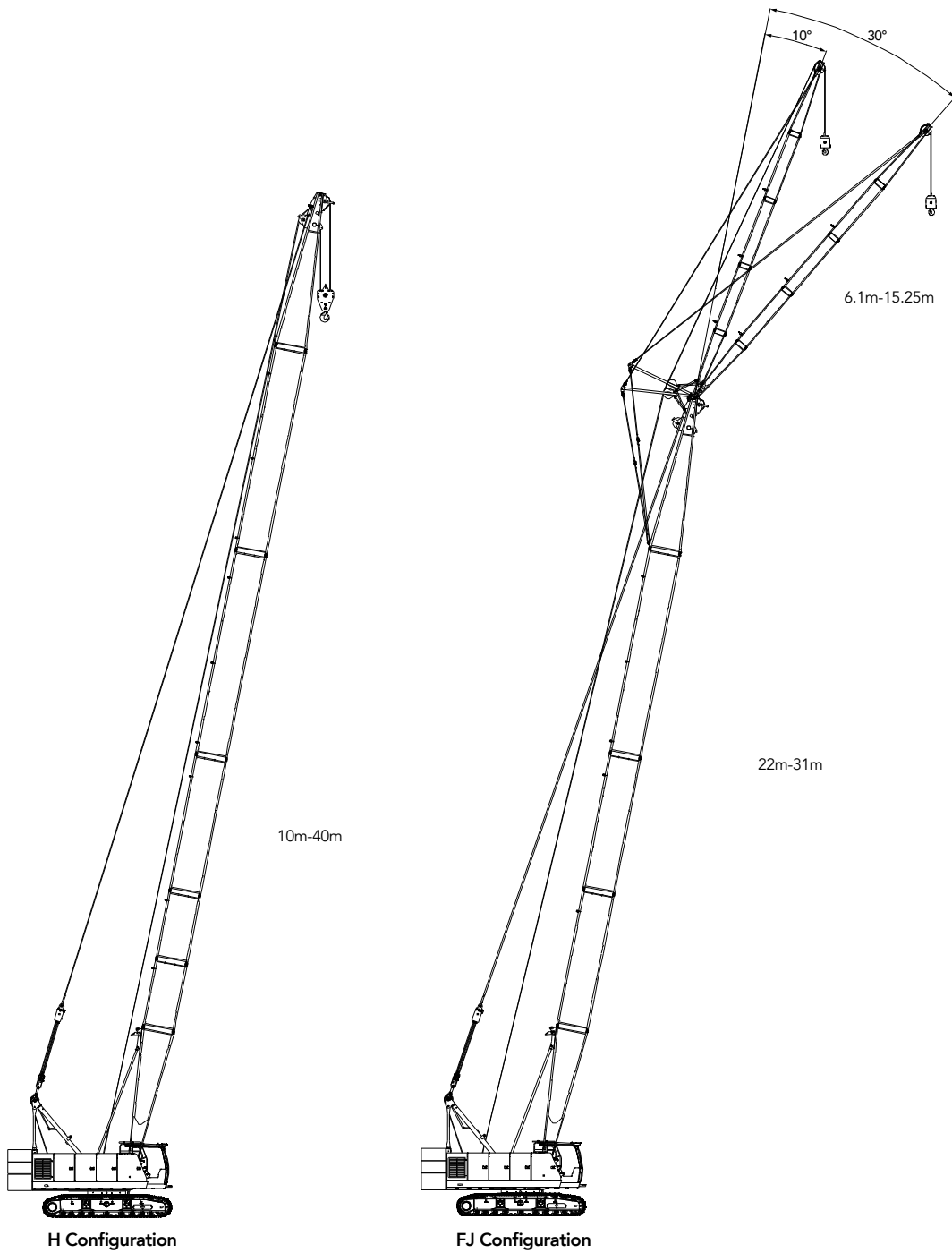

H Configuration

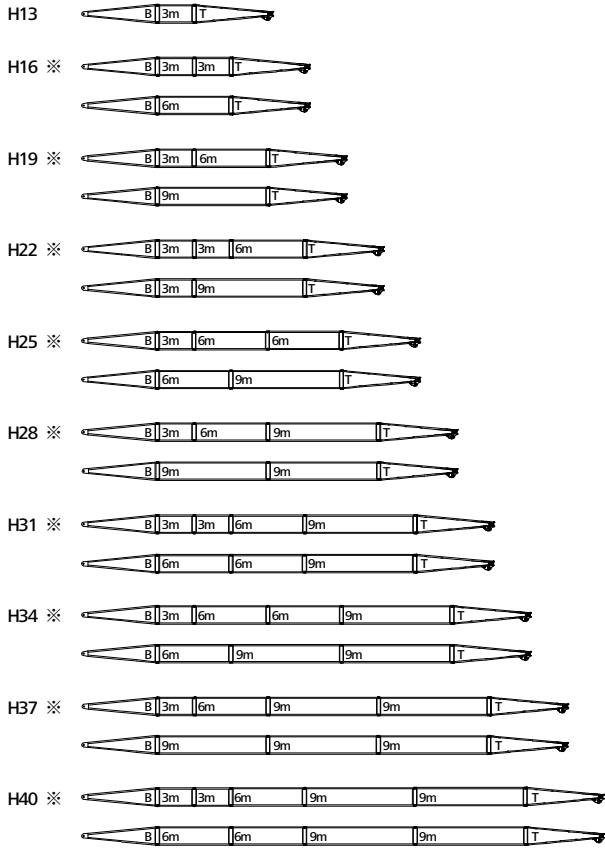

Note: Boom combination with ※ are the most flexible configuration that can be re-arranged to all the shorter boom combinations.

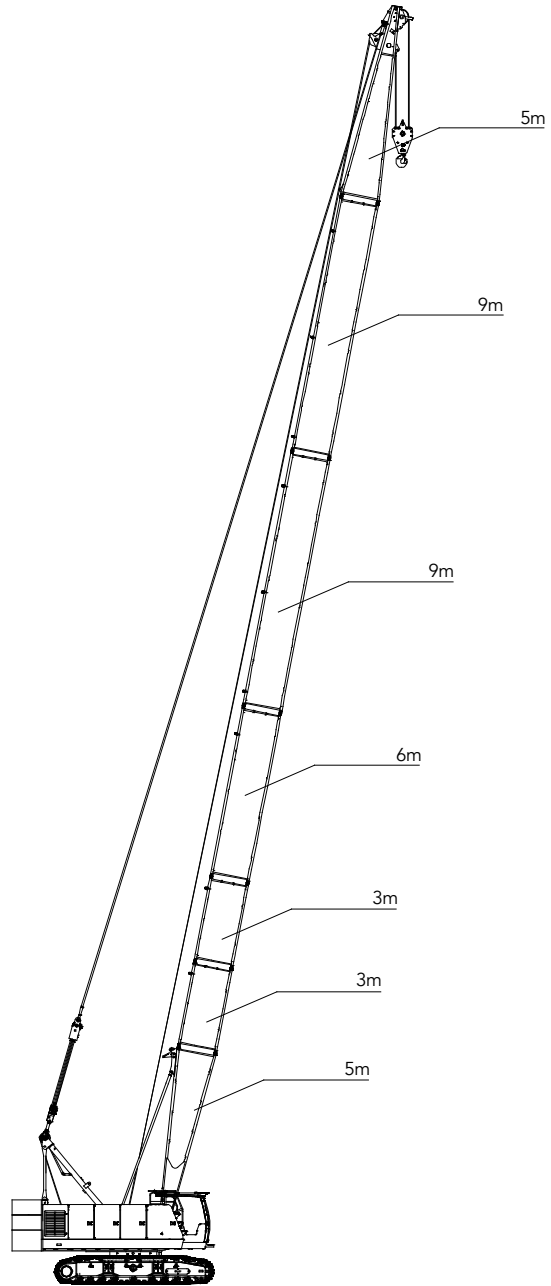
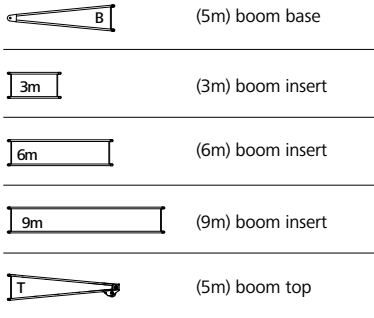

Working Radius in H Configuration

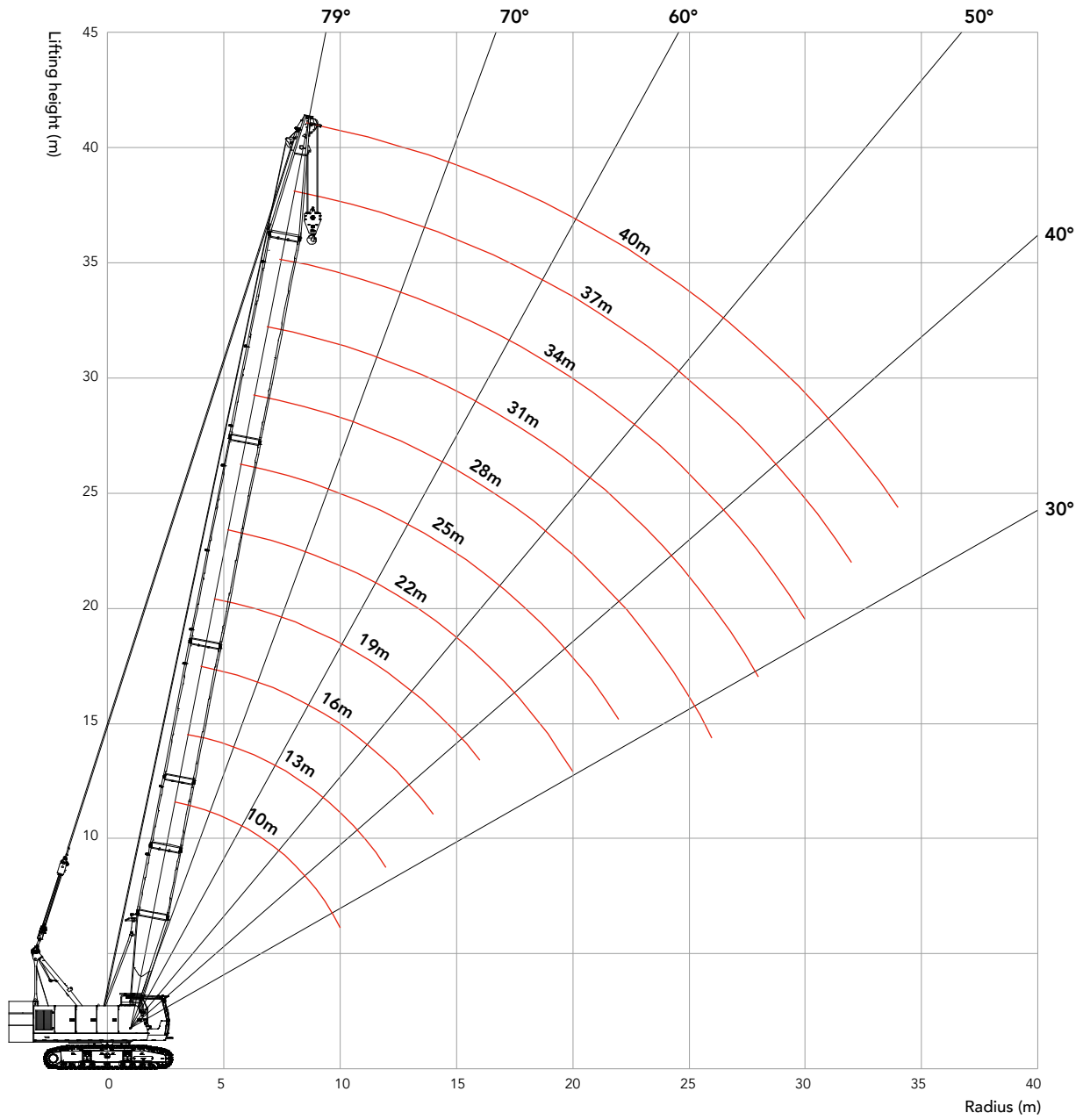

Load Chart of H Configuration

SCC450A Crawler Crane –H Configuration												
R/BL (m)	Rear Counterweight 10t											R/BL (m)
	10	13	16	19	22	25	28	31	34	37	40	
3.3	45											3.3
4	37.5	37.5	35.9									4
5	25.4	25.4	25.4	25.4	24.7							5
6	19.2	19.1	19.1	19.1	19.1	19	18.7					6
7	15.3	15.3	15.3	15.2	15.2	15.2	15.2	15.1	14.8			7
8	12.8	12.7	12.7	12.6	12.6	12.6	12.5	12.5	12.5	12.4	12.1	8
9	10.9	10.9	10.8	10.8	10.7	10.7	10.7	10.6	10.6	10.5	10.5	9
10		9.4	9.4	9.4	9.3	9.3	9.2	9.2	9.1	9.1	9	10
11		8.3	8.3	8.3	8.2	8.2	8.1	8.1	8	8	7.9	11
12		7.5	7.4	7.4	7.3	7.3	7.2	7.2	7.1	7.1	7	12
14			6.1	6	6	5.9	5.9	5.8	5.8	5.7	5.7	14
16				5.1	5	5	4.9	4.9	4.8	4.8	4.7	16
18					4.3	4.2	4.2	4.1	4.1	4	4	18
20						3.7	3.6	3.6	3.5	3.5	3.4	20
22						3.2	3.2	3.1	3.1	3	2.9	22
24							2.8	2.7	2.7	2.6	2.6	24
26								2.4	2.4	2.3	2.2	26
28									2.1	2	2	28
30									1.9	1.8	1.7	30
32										1.6	1.5	32
34											1.4	34

Notes: Rated capacity of crawler crane

- ① The rated capacity in the load charts is calculated when the crane is parking on firm and level ground, lifting the load slowly and steadily.
- ② The rated capacity values in the load charts are only valid when wind speed is lower than 9.8m/s.
- ③ The rated capacity in the load charts includes the weight of hook, wire rope and other riggings; therefore, the actual rated capacity shall deduct the weight of these components.
- ④ The crawlers must be extended during lifting.
- ⑤ The values in the load charts are valid for 360° swing.
- ⑥ The values in the load charts are preliminary, which are subject to further tuning.

FJ Configuration

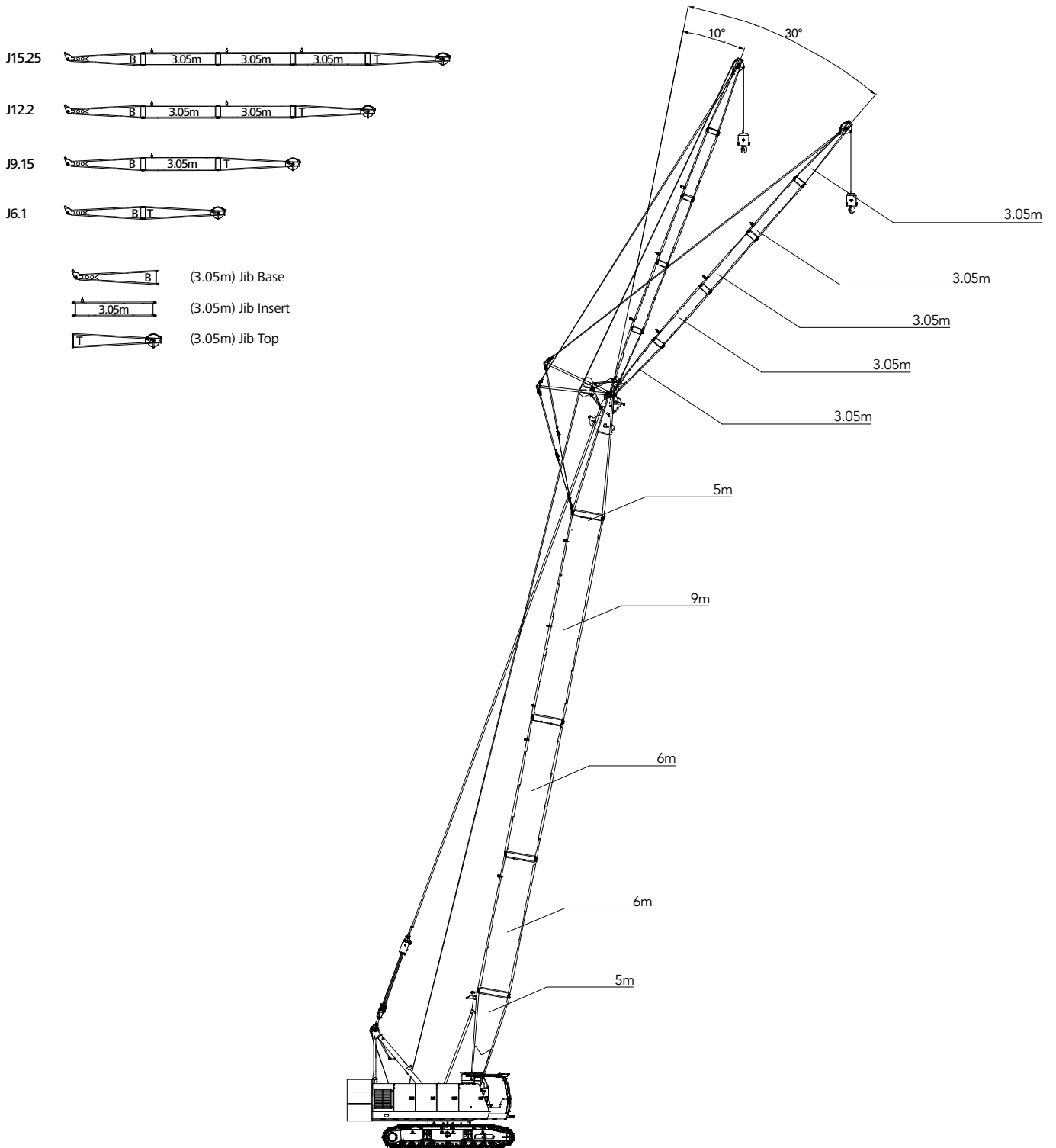

Longest boom + jib: 31m+15.25m

Working Radius in FJ Configuration

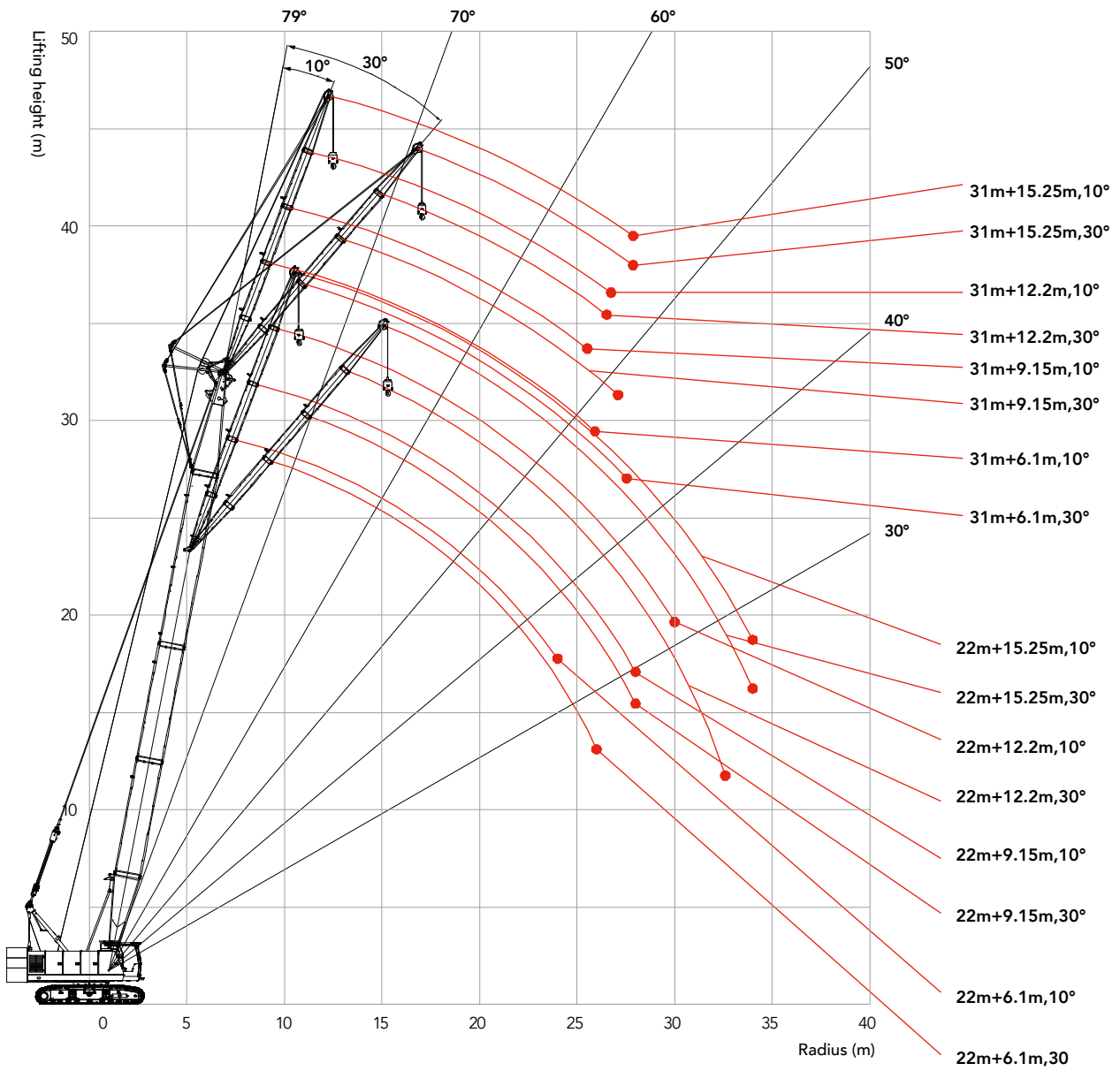

Unit: t

Load Chart of FJ Configuration

SCC450A Crawler Crane – FJ Load Chart 1/8						
Boom length 22~31m, Boom to jib angle 10° , Jib 6.1m, Rear Counterweight 10t						
R(m)	Jib angle	22	25	28	31	Jib angle R(m)
7		5				7
8		5	5	5		8
9		5	5	5	5	9
10		5	5	5	5	10
11		5	5	5	5	11
12		5	5	5	5	12
14		5	5	5	5	14
16		5	4.9	4.9	4.8	16
18		4.2	4.2	4.1	4.1	18
20		3.7	3.6	3.6	3.5	20
22		3.2	3.1	3.1	3	22
24		2.8	2.8	2.7	2.6	24
26			2.4	2.4	2.3	26
28			2.2	2.1	2.1	28
30				1.9	1.8	30
32					1.6	32
Counterweight(t)		10	10	10	10	Counterweight(t)

Load Chart of FJ Configuration

SCC450A Crawler Crane – FJ Load Chart 2/8						
Boom length 22~31m, Boom to jib angle 10° , Jib 9.15m, Rear Counterweight 10t						
R(m)	Jib angle	22	25	28	31	Jib angle R(m)
8		5				8
9		5	5	5		9
10		5	5	5	5	10
11		5	5	5	5	11
12		5	5	5	5	12
14		5	5	5	5	14
16		5	5	4.9	4.8	16
18		4.3	4.2	4.2	4.1	18
20		3.7	3.6	3.6	3.5	20
22		3.2	3.2	3.1	3	22
24		2.8	2.8	2.7	2.7	24
26		2.5	2.5	2.4	2.3	26
28		2.2	2.2	2.1	2.1	28
30			2	1.9	1.8	30
32				1.7	1.6	32
34					1.4	34
36					1.3	36
Counterweight(t)		10	10	10	10	Counterweight(t)

Unit: t

Load Chart of FJ Configuration

SCC450A Crawler Crane – FJ Load Chart 3/8						
Boom length 22~31m, Boom to jib angle 10° , Jib 12.2m, Rear Counterweight 10t						
R(m)	Jib angle	22	25	28	31	Jib angle R(m)
9		5				9
10		5	5	5		10
11		5	5	5	5	11
12		5	5	5	5	12
14		5	5	5	5	14
16		5	5	4.9	4.9	16
18		4.3	4.2	4.2	4.1	18
20		3.7	3.7	3.6	3.5	20
22		3.2	3.2	3.1	3.1	22
24		2.9	2.8	2.8	2.7	24
26		2.5	2.5	2.4	2.4	26
28		2.3	2.2	2.2	2.1	28
30		2	2	1.9	1.9	30
32			1.8	1.7	1.6	32
34			1.6	1.5	1.5	34
36				1.4	1.3	36
38					1.1	38
Counterweight(t)		10	10	10	10	Counterweight(t)

Load Chart of FJ Configuration

SCC450A Crawler Crane – FJ Load Chart 4/8						
Boom length 22~31m, Boom to jib angle 10° , Jib 15.25m, Rear Counterweight 10t						
R(m)	Jib angle	22	25	28	31	Jib angle R(m)
10		5				10
11		5	5	5		11
12		5	5	5	5	12
14		5	5	5	5	14
16		5	5	4.9	4.9	16
18		4.3	4.3	4.2	4.2	18
20		3.7	3.7	3.6	3.6	20
22		3.3	3.2	3.2	3.1	22
24		2.9	2.8	2.8	2.7	24
26		2.5	2.5	2.4	2.4	26
28		2.3	2.2	2.2	2.1	28
30		2	2	1.9	1.9	30
32		1.8	1.8	1.7	1.7	32
34		1.7	1.6	1.5	1.5	34
36			1.4	1.4	1.3	36
38				1.2	1.1	38
40					1	40
Counterweight(t)		10	10	10	10	Counterweight(t)

Note: the values shaded are determined by boom strength.

Unit: t

Load Chart of FJ Configuration

SCC450A Crawler Crane – FJ Load Chart 5/8						
Boom length 22~31m, Boom to jib angle 30° , Jib 6.1m, Rear Counterweight 10t						
R(m)	Jib angle	22	25	28	31	Jib angle R(m)
9		5				9
10		5	5	5		10
11		5	5	5	5	11
12		5	5	5	5	12
14		5	5	5	5	14
16		5	5	5	4.9	16
18		4.3	4.3	4.2	4.2	18
20		3.7	3.7	3.6	3.6	20
22		3.2	3.2	3.1	3.1	22
24		2.8	2.8	2.8	2.7	24
26		2.5	2.5	2.4	2.4	26
28			2.2	2.1	2.1	28
30				1.9	1.8	30
32					1.6	32
Counterweight(t)		10	10	10	10	Counterweight(t)

Load Chart of FJ Configuration

SCC450A Crawler Crane – FJ Load Chart 6/8						
Boom length 22~31m, Boom to jib angle 30° , Jib 9.15m, Rear Counterweight 10t						
R(m)	Jib angle	22	25	28	31	Jib angle R(m)
11		5				11
12		5	5	5		12
14		5	5	5	5	14
16		5	5	5	5	16
18		4.4	4.3	4.3	4.2	18
20		3.8	3.7	3.7	3.6	20
22		3.3	3.2	3.2	3.2	22
24		2.9	2.9	2.8	2.8	24
26		2.6	2.5	2.5	2.4	26
28		2.3	2.2	2.2	2.1	28
30			2	2	1.9	30
32				1.7	1.7	32
34				1.5	1.5	34
36					1.3	36
Counterweight(t)		10	10	10	10	Counterweight(t)

Unit: t

Load Chart of FJ Configuration

SCC450A Crawler Crane – FJ Load Chart 7/8						
Boom length 22~31m, Boom to jib angle 30° , Jib 12.2m, Rear Counterweight 10t						
R(m)	Jib angle	22	25	28	31	Jib angle R(m)
14		4.9	4.8	4.6		14
16		4.5	4.5	4.3	4.3	16
18		4.3	4.3	4.1	4.1	18
20		3.8	3.8	3.8	3.7	20
22		3.3	3.3	3.3	3.2	22
24		2.9	2.9	2.9	2.8	24
26		2.6	2.6	2.5	2.5	26
28		2.3	2.3	2.2	2.2	28
30		2.1	2	2	1.9	30
32		1.8	1.8	1.8	1.7	32
34			1.6	1.6	1.5	34
36				1.4	1.3	36
38					1.2	38
40					1	40
Counterweight(t)		10	10	10	10	Counterweight(t)

Note: the values shaded are determined by boom strength.

Load Chart of FJ Configuration

SCC450A Crawler Crane – FJ Load Chart 8/8						
Boom length 22~31m, Boom to jib angle 30° , Jib 15.25m, Rear Counterweight 10t						
R(m)	Jib angle	22	25	28	31	Jib angle R(m)
16		3.9	3.8	3.6		16
18		3.6	3.6	3.5	3.4	18
20		3.5	3.4	3.3	3.2	20
22		3.3	3.2	3.1	3.1	22
24		3	2.9	2.9	2.9	24
26		2.6	2.6	2.6	2.5	26
28		2.4	2.3	2.3	2.2	28
30		2.1	2.1	2	2	30
32		1.9	1.8	1.8	1.8	32
34		1.7	1.7	1.6	1.6	34
36			1.5	1.4	1.4	36
38				1.3	1.2	38
40				1.1	1.1	40
Counterweight(t)		10	10	10	10	Counterweight(t)

Note: the values shaded are determined by boom strength.



Zhejiang SANY Equipment Co., Ltd.

SANY Industrial Park, No. 2087 Daishan Road, Wuxing District, Huzhou City,
Zhejiang Province, P. R. of China Zip 313028
After-sales Service 400 887 8318
Consulting 400 887 9318

— Agent information —

Due to updated technology, the technical parameters and configurations are subject to change without prior notice. The machine in the picture may include additional equipment. This album is for reference only, subject to the object.
All rights reserved for Sany, without the written permission of Sany, the contents of any part of this content shall not be copied or copied for any purpose.

© Printed in June 2019 in China

www.sany.com.cn



Please scan the official WeChat account of Sany for more information.